

# Intelligent Vacuum Pump User Manual

## V700/V900/V1200







# Contents

- Disclaimer .....1
- Product Features .....2
- Technical Parameters .....2
- Service Parts .....3
- Operation Guide .....4
- Care and Maintenance .....9
- App Operating Instructions .....11

# Disclaimer

- The vacuum pump is heavy. Be careful while handling to prevent personal injury.
- Use only 46 mechanical oil to avoid vacuum pump damage.
- Do not cover the exhaust port during vacuum pump operation.
- Do not expose the suction port continuously to atmosphere for more than 3 minutes.
- The air inlet pressure should not exceed 27.5 bar to avoid sensor damage.

# Warning Signs

Sign	Name	Content
	Check the Oil Level	Add 46 mechanical oil before the first use and keep the oil level between the maximum and minimum level
	Wear Goggles	Wear goggles when working with refrigerants . Direct contact with refrigerants may cause injury
	Beware of High Temperature Burns	The pump surface becomes hot during normal operation. Do not touch the pump body or motor during operation
	Avoid Electrical Shock Hazards	Improper use may cause electrical shock hazards Read and follow the instructions carefully and take precautions to avoid electrical shock hazards . Confirm that all associated devices are grounded correctly before power on
	Danger	Please remove the exhaust cap before starting up
		Check the oil level and prohibit running without oil

# Product Features

- Intelligent Control of Motor and Solenoid Valve
- Leakage Level Judgment
- Vacuum Change in Graph
- 4" Touch Screen Display
- Estimated Job Completion Time
- Data Logging and Storage via App

# Technical Parameters

Models	V700	V900	V1200
Stage	2 stages		
Power Supply	110V/60Hz; 220V/50Hz		
Motor	AC induction motor		
Speed Regulation	Fixed speed		
Vacuum Accuracy	1-10000microns ±10% of Reading / ±10microns 10000-19000 microns ±20% of Reading		
Operating Temperature	41°F~104°F (5°C~40°C)		
Transmission Distance	30ft / 10m		
Limit Vacuum	15 microns		
Pumping Rate	7 CFM (3L/S)	9 CFM (4L/S)	12 CFM (5L/S)
Motor Power	3/4 HP ( 550 W )	1 HP ( 750 W )	1 HP ( 750 W )
Fuel Volume	22oz /(650ml)	22 oz /(650ml)	25.3 oz(750ml)
Overall Dimension	18.5in×10.5in×14.8in / (470mm*267mm*380mm)		
Weight	34.2lbs / 14.8kg	35.3lbs / 15.3kg	36.8lbs / 16kg
Air Inlet	1/4 SAE		

# Service Parts

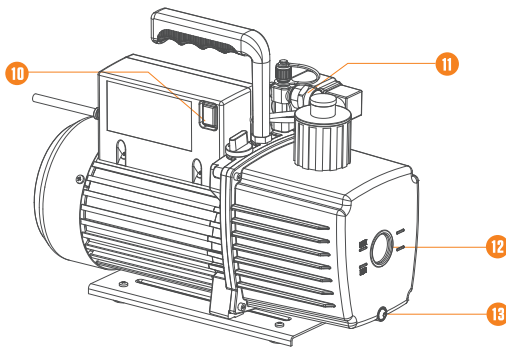
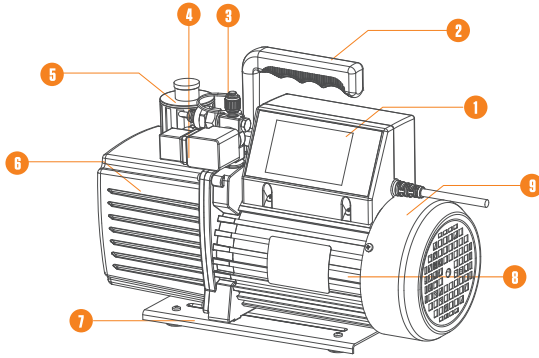

① Display screen	⑧ Motor
② Handle	⑨ Motor housing
③ Air inlet	⑩ Power button
④ Solenoid valve	⑪ Vacuum sensor
⑤ Catcher	⑫ Oil window
⑥ Oil tank	⑬ Oil drain plug
⑦ Base	

# Operation Guide

Conditions that must be met

1. Place on a flat surface.
2. Confirm the voltage and frequency at the outlet match with the vacuum pump specifications.
3. Confirm the oil level is within the Min and Max level.
4. Remove the air inlet cap (1/4 SAE fitting as shown in the right image ), connect the pumped system (make sure the pipe fitting is fit with the air inlet fitting). Tighten the air inlet and make sure the system and hoses are sealed with no leakage.
5. Plug in the power cord and open the exhaust port.

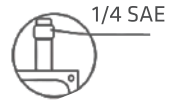



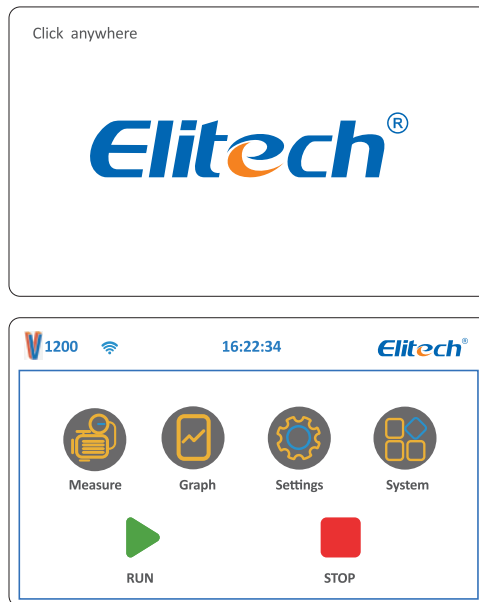

## Interface Introduction





### Main interface





(1) The status bar on top of the page shows the product model, time, Bluetooth status and record status.

- ① Model numbers varies depending on the product models.
- ②  Bluetooth not connect;  Bluetooth connected.
- ③ During operation,  appear when temperature exceeds the upper alarm limit, and  appear when temperature below the lower alarm limit.
- ④ Record: close means no data is recorded. Record: Open means that data is being recorded.

(2) The middle part of the page is the sub-interface button.

- ①  : Real-time measurement interface
- ②  : Graph
- ③  : Vacuum parameter setting
- ④  : System parameter display and setting

(3) "RUN" and "STOP" button displays in every operation interface. The motor is off by default after power-on. Click "  " to start the motor. Click "  " to stop the motor.

### 1. Real time measurement interface

Click the "Measure" button on the main interface to enter the real-time measurement interface.

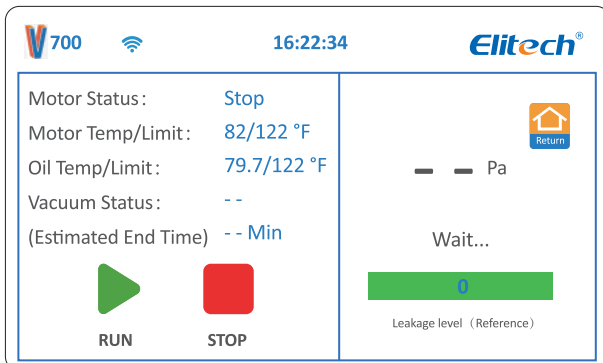

- (1) Motor Status: show the current status of the motor.
- (2) Motor Temp/Limit: show the surface temperature of the pump chassis and set the alarm temperature.
- (3) Oil temperature: show vacuum pump oil temperature and set the alarm temperature.
- (4) Vacuum status: display the current vacuum value status, "Decrease", "Stable", "Rise", "--".
- (5) Estimated End Time: when the vacuum is stable, it shows the estimated job completion time including holding time.
- (6) Vacuum: show real time vacuum value.
- (7) Leakage level: when the vacuum is stable, check the leakage possibility from 0 to 100 levels. 0 represent uncertain leakage. The larger the number, the greater the possibility of the leakage.
- (8)  Key: return to the main interface.

## 2. Graph

Click the "Graph" button on the main interface to view the vacuum change in real time.

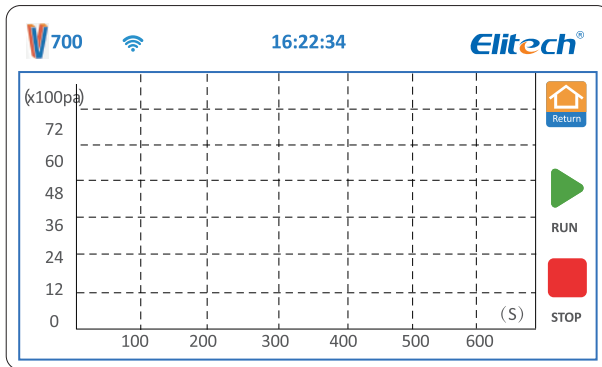

- (1) When the vacuum value drops below 8000 Pa, the vacuum change graph is displayed.
- (2) The X axis represent time. Y axis represent vacuum. The vacuum value is from 0 Pa to 8000 Pa.
- (3)  Key: return to the main interface.



### 3. Settings

Click the “Settings” button on the main menu to enter the setting interface.

#### Unit (P/T)

Select Unit to set the unit for vacuum and temperature. The selected units are in blue.

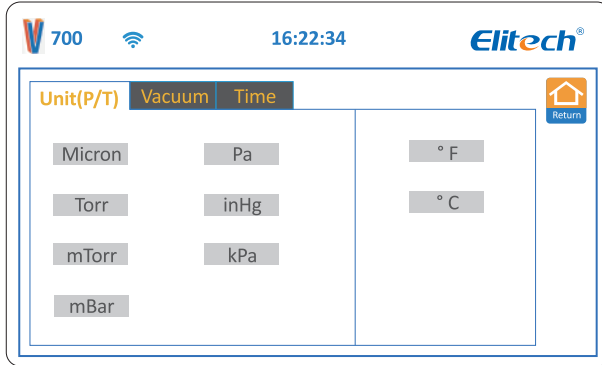

#### Vacuum

Set the minimum vacuum value, logging interval, and recording status.

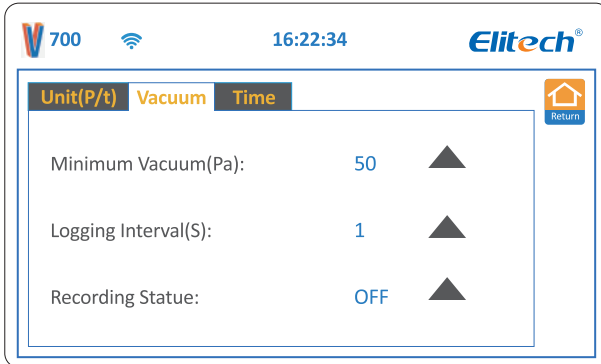

- (1) Minimum vacuum: set the target vacuum value. The range of the minimum vacuum value is 0.3Pa-100Pa. Click the change button to switch the minimum vacuum value; the display unit changes according to the selected unit.
- (2) Logging interval (in second): 1, 5, 10, 30, 60, 120, 300.
- (3) Recording status: The logging can be turned on and off. The upper right corner shows the logging/recording status.

## Time

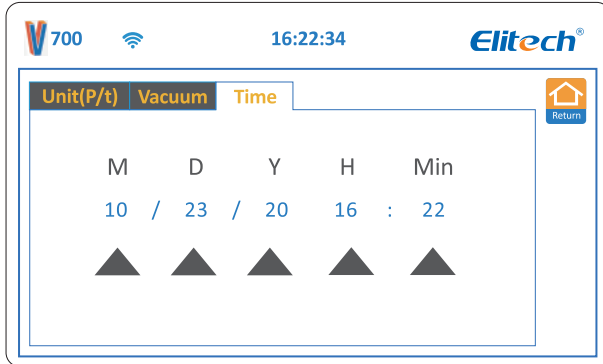

- (1) Set and save the time then it shows at the top of the screen.
- (2) ▲ : Change key.
- (3) 🏠 : return to the main interface.

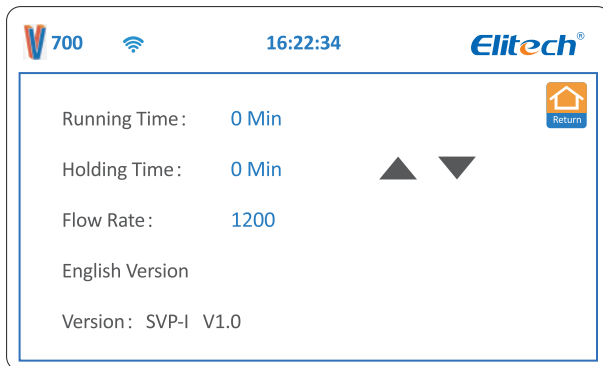

## 4. System

In the main menu, click the “ System” button to enter the system interface.



- (1) Running time: refer to the accumulated running time of the motor.
- (2) Holding time: refer to the time for the vacuum pump to continue vacuuming after the target vacuum value is stable.
- (3) Flow Rate: refer to the pumping speed of the vacuum pump.
- (4) ▲ : Change key.
- (5) 🏠 : return to the main interface.

## Other functions

1. Temperature alarm: When the oil temperature or motor chassis temperature exceeds the upper limit alarm temperature set by the APP, the motor and solenoid valve are closed, the temperature alarm icon "  " is displayed at the top of the screen; When the temperature decrease within the alarm temperature, the alarm will be cleared, and the vacuum work continues . If temperature exceeds the offline alarm temperature, the temperature alarm icon "  " will be displayed on the top of the vacuum pump screen, the motor operation will not be affected.

## 5. After using the vacuum pump

1. Close the valve between the pump and the pumped container.
2. Turn off the power switch on the pump, unplug the power plug, and remove the connecting pipe.
3. Finally, close the air inlet cap to prevent dirt or floating particles from entering the pump cavity.

# Care And Maintenance

## Precautions

1. Check the oil level to avoid running out of oil.
2. During operation, storage and transportation, keep the vacuum pump clean to prevent pollutants such as water, mechanical impurities, etc. from entering the pump so as not to affect the service life of the vacuum pump and the normal operation of the system.
3. The oil in the pump should be drained if it is not used for a long time. Store the pump in a dry and clean environment.
4. The diameter of the pipe is larger than the inner diameter of the air inlet to avoid affecting the pumping speed.
5. Check the tightness of the pipe connection to prevent leakage. Recommend using the vacuum grease on the connection and clamp it with a clamp to ensure the seal.
6. Do not use the pump to pump out gases which contain high level of oxygen, metal corrosive and explosive gases. In addition, do not pump in any gases that react with pump oil and containing large amount of water vapor.
7. It is recommended to clean the catcher once every half year.

### How to replace the vacuum pump oil

1. Run the pump for about 3-5minutes until it is warmed up to runs out the pump oil.
2. Keep the air inlet open and let the oil in the pump flow out. Turn off the pump and remove the drain plug to discharge the waste oil.
3. Tilt the pump body to completely drain the residual oil, and tighten the drain plug.
4. Open the catch device and add the new pump oil.
5. Cover the air inlet cap and start the pump to run-check the oil level after one minute. If the oil level is below the lower limit, slowly add the oil until it reaches the normal oil level. Finally, screw on the catcher.

## Troubleshooting Guide



Failure Phenomenon	Cause of Issue	Troubleshooting Method
Low Vacuum	1. Insufficient Oil	Add oil between the maximum and minimum level
	2. Pump oil Emulsified, Polluted	Replace with new oil
	3. The Oil Inlet Is Blocked or the Oil Supply is Insufficient	Clean the oil inlet and filter
	4. Leakage of the Pump System and Connection	Check the system and the connection to prevent the leakage
	5. Improper Selection of Pump	Check the size of the pumped container, recalculate and select the appropriate type of pump
	6. Parts Wear and Tear due to Long Time Used.	Repair or replace with a new pump
Oil Leakage	1. The Oil Seal Is Damaged	Replace oil seal
	2. Loose or Damaged Tank Connections	Tighten the screws and replace the O-ring

Fuel Injection	1. Too Much of Oil	Drain the oil to the oil level line
	2. The Air Inlet Is Over Pressured for a Long Time	Choose a pump with larger pumping speed
Difficulty Starting	1. Oil Temperature is Too Low	Open the air inlet, start the motor repeatedly or heat up the pump oil
	2. Motor Failure	Check and repair
	3. Foreign Objects Fallen into the Pump	Check and clean
	4. Power Failure	Check and repair
	5. The Power Supply Voltage Is Too Low	Check the power supply voltage

## APP Operating Instructions

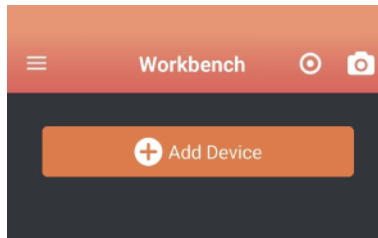
1. Power on the vacuum pump.
2. Turn on the Bluetooth function of the mobile phone.
3. Open the “Elitech Gauge” APP.



4. Click "Add device" to enter the device management interface. And the devices that can be connected are displayed in red. Click  on the top right of the device to establish a connection. After successful connection, the device bar turns green and the Bluetooth icon displays .

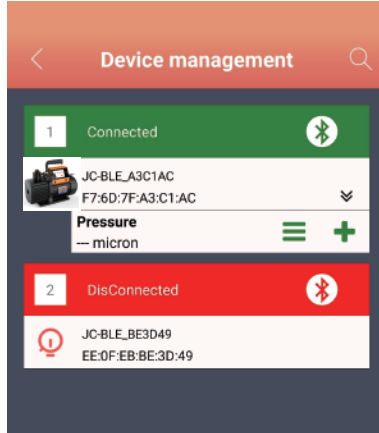





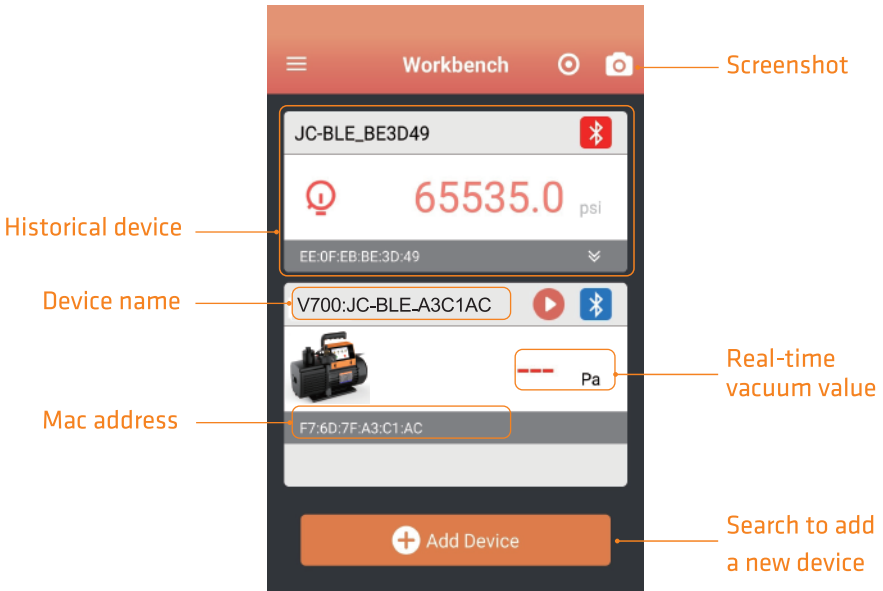

5. For the connected device, click at the bottom right of the device to add the device to the work interface. The bottom of the screen shows that the device has been added successfully.

6. Click the return button in the upper left corner of the device management interface to enter the work interface.



The interface includes historical devices and the new devices.

- (1) The history device displays the previously connected devices, click the device bar to automatically connect the device. When the connection is successful, and "  "
- (2)  : after clicking it will search for new devices.
- (3)  : Bluetooth is not connected, click and try to connect this device.
- (4)  : Bluetooth has been connected successfully, click to disconnect.
- (5)  : Motor stop status, click to start running.
- (6)  : Motor running status, click to stop the motor.
- (7) Real-time vacuum value: display the real-time vacuum value.

7. Click “☰” in the top left corner of the working interface to enter the menu.  
 (Only some functions related to vacuum pump are described here).

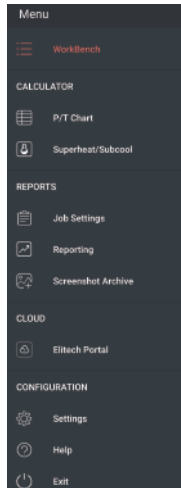

(1) Report

- ① Work: Click the work button to enter the work list. Add a work list at the top right.  
 Add work information and save the work.

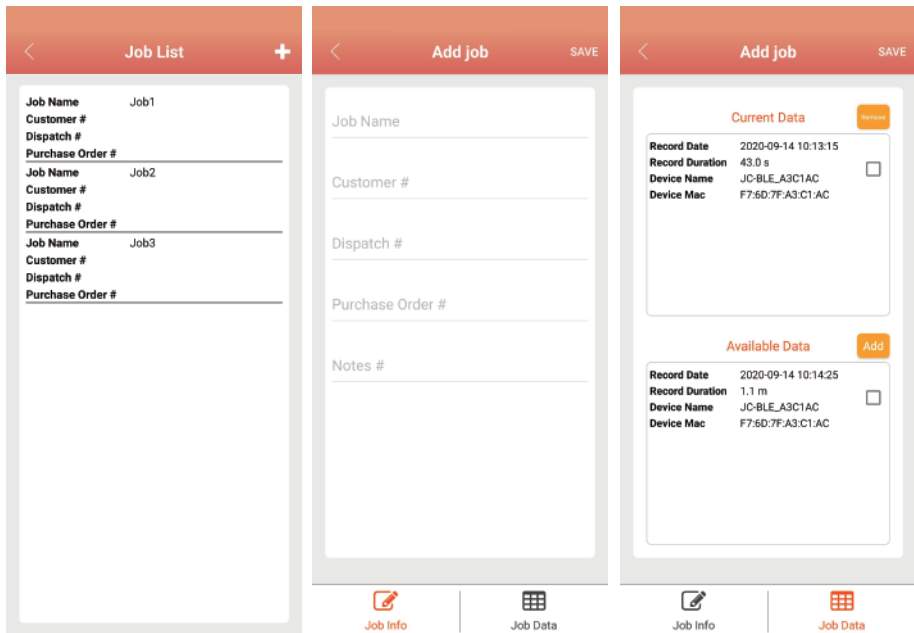



② Report: Click the report button to enter the report interface.

Click the New report button, select data information by work or time, click the chart analysis button to view historical graph, click the “Export” button at the bottom to export data in Excel or PDF.

Click the saved report to view historical Excel and PDF reports, and long press the report to delete.

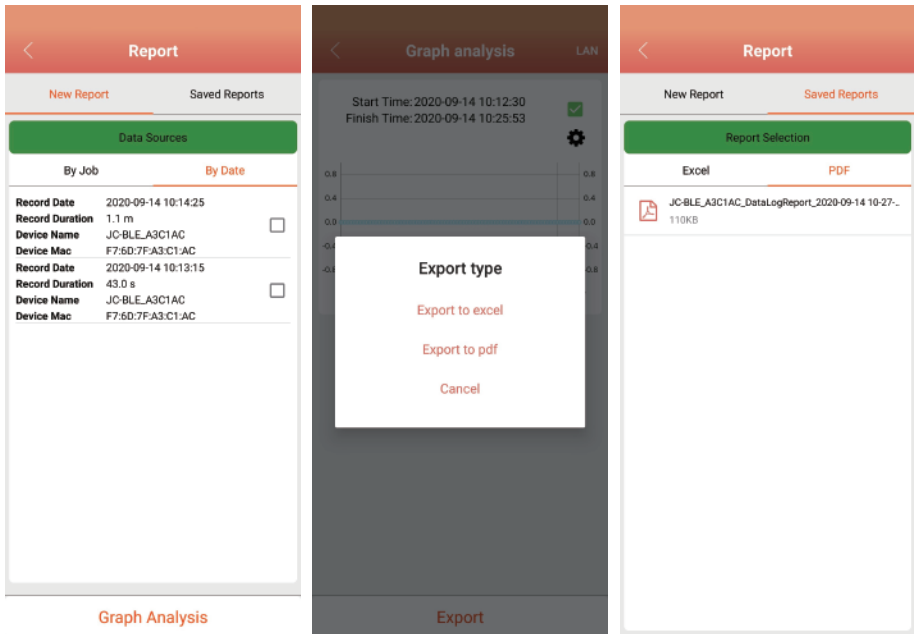

③ Screen capture : save the screen capture file of the work interface. The file type is PDF.

## (2) Configuration

① Setting: Click the "Setting" button to enter the system settings.

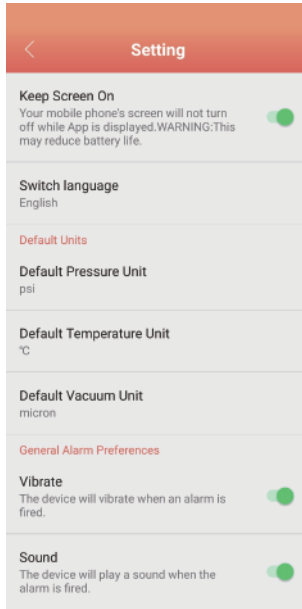

**Backlight on:** control the backlight of the screen.

**Switch language:** select language English or Other Languages.

**Alarm mode setting:** single sound, single vibration or sound vibration alarm at the same time.

② Help: Click the "Help" button to enter the help interface; click the "About button" to obtain version information; click "User Manual" to enter the download interface, and click the "Start" button to download the vacuum pump user manual.

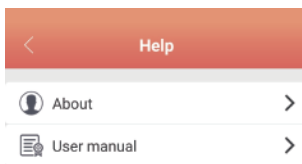

③ Exit: Click the "exit" button to exit the APP.

## 8. Main interface

Click the connected device icon to enter the detailed interface of the device, display the vacuum pump status, and control the vacuum pump.

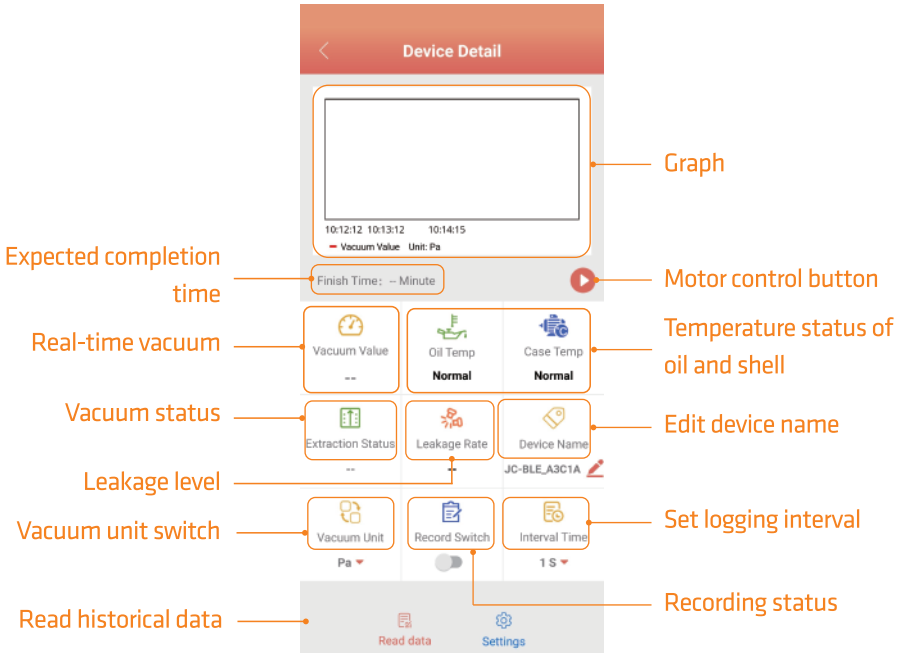

- (1) Graph: when the vacuum value drops below 8000Pa, the real-time vacuum graph will be displayed.
- (2) Expected completion time: when the vacuum status is close to stable, the remaining vacuuming time will be displayed including the holding time.
- (3) Motor control: motor stop status displays "▶", click to run the motor; the motor running status displays "⏸", click to stop the motor.
- (4) Real-time vacuum: display the real-time vacuum value.
- (5) Temperature status of oil and shell: According to the setting alarm temperature, display the temperature status "high", "normal", and "low".
- (6) Vacuum status: display the current vacuum value status, "Decrease", "Stable", "Rise", "--".

- (7) Leakage level: Under the stable state of the vacuum value, make a judgment on the possibility of leakage of the current system, which is represented by 0-100; 0 means the uncertain of the leakage status. The larger the number, the possibility of leakage is larger.
- (8) Edit device name: modify the device name, support up to 10 characters and numbers, click OK to confirm.
- (9) Vacuum unit: select vacuum unit, inHg , Torr, mbar, mTorr, Pa, micron, kPa.
- (10) Recording status: vacuum pump data recording switch, closed by default.
- (11) Logging interval: select logging interval, 1S, 5S, 10S, 30S, 1Min, 2 Min, 5 Min.
- (12) Read historical data: read the value saved by the vacuum pump while recording.  
Before reading the data, it will remind whether to delete the data after reading.

9. Settings

Click Settings to set parameters and alarm values of vacuum pump.

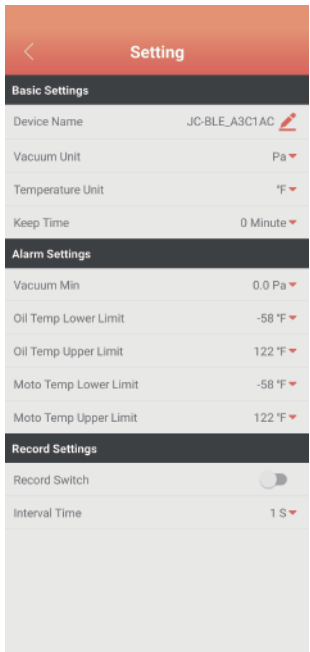

## (2) Basic settings

- ① Device name: modify the device name, support up to 10 characters and numbers, click OK to save the device name.
- ② Vacuum unit: select vacuum unit, inHg, Torr, mbar, mTorr, Pa, micron, kPa.
- ③ Temperature unit: select the temperature unit, °C, °F.
- ④ Holding time: the continue working time after reaching the target vacuum, the setting range is 0 to 200 minutes.

## (3) Alarm settings

- ① Vacuum alarm setting: when the vacuum reaches the alarm value, the mobile phone will alarm and vibrate.
- ② Temperature alarm setting: set the max and minimum oil temperature and chassis temperature alarm. The temperature range of vacuum pump is -50°C to 85°C. The minimum temperature shall not exceed the max temperature. When the alarm temperature is triggered, the mobile phone will alarm with sound and vibration.

## (4) Record settings

- ① Recording status: set vacuum pump data recording status, closed by default.
- ② Logging interval: set the logging interval , 1S, 5S, 10S, 30S, 1Min, 2 Min, 5 Min.

iOS system: Enter the APP Store and search for "Elitech Gauge" to download.

Android system: Enter Google Play search for "Elitech Gauge" to download or scan QR code below to download.



Android system



iOS system

# Product Warranty Card

Product Model Number	Product Name
Factory Serial Number	
Purchase Store	
Purchase Date	Invoice number
Customer Name	Customer Phone
Customer Address	

*This coupon and the purchasing invoice are both considered as the Protection to fix warrantees, so please reserve them carefully.*

## Protection to Fix Elucidation

According to the prescription, the period for protecting to fix our company's Intelligent vacuum pump is one year. (From the day when you have the invoice) During this period, any belongs to under normal usage circumstance cause because of the product quality's problem of breakdown, our company will be responsible for giving free maintain.

## Free maintain won't be given under the following circumstance :

- Without Protection to fix warrantees.
- The breakdown caused by the manipulation that hasn't follow the requests of the Manual.
- The damage caused by the dismantle movement of a non-our-company authorized maintainer.
- The breakdown, row harm or damaged because of the move or drop.
- The damage caused by customer inappropriate preservation, maintain, or the usage.
- Easy damaged pieces and present accessories are not concerned.
- The breakdown and the damage caused by the Force majeure.

**Elitech**<sup>®</sup>  
*Innovation Preceding All*



Made in China V1.0