

TEST REPORT

Report Number	: ZKT-2104191296E
Date of Test.....	: Apr. 15, 2021 - Apr. 21, 2021
Date of issue.....	: Apr. 22, 2021
Total number of pages.....	: 28
Test Result	: PASS
Testing Laboratory	: Shenzhen ZKT Technology Co., Ltd.
Address	: 1/F, No. 101, Building B, No. 6, Tangwei Community Industrial Avenue, Fuhai Street, Bao'an District, Shenzhen, China
Applicant's name	: Elitech Technology, Inc.
Address	: 2528 Qume Dr, Ste 2 San Jose, CA 95131.
Manufacturer's name	: Jiangsu Jingchuang Electronics Co.,Ltd.
Address	: No.21 Zhujiang East Road, 3rd Industrial Park, High-tech Industrial Development Zone, Xuzhou, Jiangsu, China
Test specification:	
Standard.....	: EN 61326-1:2013
Test procedure.....	: /
Non-standard test method	: N/A
Test Report Form No	: TRF-EL-148_V0
Test Report Form(s) Originator	: ZKT Testing
Master TRF	: Dated: 2020-01-06
<p>This device described above has been tested by ZKT, and the test results show that the equipment under test (EUT) is in compliance with the 2014/30/EU Directive requirements. And it is applicable only to the tested sample identified in the report.</p> <p>This report shall not be reproduced except in full, without the written approval of ZKT, this document may be altered or revised by ZKT, personal only, and shall be noted in the revision of the document.</p>	
Product name	: Electronic Refrigerant Scale
Trademark	: N/A
Model/Type reference.....	: LMC-100F LMC-100A, LMC-200, LMC-200A, LMC-210, LMC-210A, LMC-300, LMC-300A, LMC-310, LMC-310A, LMC-210L, LMC-300L
Ratings.....	: DC 9V by the battery

Testing procedure and testing location:

Testing Laboratory.....: **Shenzhen ZKT Technology Co., Ltd.**
Address.....: 1/F, No. 101, Building B, No. 6, Tangwei Community
Industrial Avenue, Fuhai Street, Bao'an District,
Shenzhen, China

Tested by (name + signature).....: **Peter Huang** 

Reviewer (name + signature).....: **Jason Wang** 

Approved (name + signature).....: **Awen He** 

TABLE OF CONTENT

	Page
1. VERSION	5
2. GENERAL INFORMATION	6
2.1 Description of Device (EUT).....	6
2.2 Tested System Details.....	6
2.3 Test Facility.....	6
2.4 MEASUREMENT UNCERTAINTY.....	6
2.5 Test Instrument Used.....	7
3. CONDUCTED EMISSIONS	9
3.1 Block Diagram Of Test Setup.....	9
3.2 Limit.....	9
3.3 Test procedure.....	9
3.4 Test Result.....	9
4. RADIATED DISTURBANCE TEST	10
4.1 Block Diagram Of Test Setup.....	10
4.2 Limits.....	10
4.3 Test Procedure.....	10
4.4 Test Results.....	11
5. HARMONIC CURRENT EMISSION TEST	13
5.1 Block Diagram of Test Setup.....	13
5.2 Test Standard.....	13
5.3 Operating Condition of EUT.....	13
5.3.1 Setup the EUT as shown in Section 6.1.....	13
5.3.2 Turn on the power of all equipment.....	13
5.3.3 Let the EUT work in test mode and test it.....	13
5.4 Test Procedure.....	13
5.5 Test Results.....	13
6. VOLTAGE FLUCTUATIONS & FLICKER TEST	14
6.1 Block Diagram of Test Setup.....	14
6.2 Test Standard.....	14
6.3 Operating Condition of EUT.....	14
6.4 Test Procedure.....	14
6.5 Test Results.....	14
7. IMMUNITY TEST OF GENERAL THE PERFORMANCE CRITERIA	15
8. ELECTROSTATIC DISCHARGE (ESD)	16
8.1 Test Specification.....	16
8.2 Block Diagram of Test Setup.....	16
8.3 Test Procedure.....	16
8.4 Test Results.....	17
9. ELECTROMAGNETIC FIELD (RS)	18
9.1 Test Specification.....	18
9.2 Block Diagram of Test Setup.....	18
9.3 Test Procedure.....	19
9.4 Test Results.....	19
10. ELECTRICAL FAST TRANSIENTS/BURST (EFT)	20
10.1 Test Specification.....	20
10.2 Block Diagram of EUT Test Setup.....	20
10.3 Test Procedure.....	20
10.4 Test Results.....	20
11. SURGES IMMUNITY TEST	21
11.1 Test Specification.....	21
11.2 Block Diagram of EUT Test Setup.....	21
11.3 Test Procedure.....	21
11.4 Test Result.....	21

12. CONTINUOUS INDUCED RF DISTURBANCES (CS)	22
12.1 Test Specification.....	22
12.2 Block Diagram of EUT Test Setup.....	22
12.3 Test Procedure.....	22
12.4 Test Result.....	22
13. VOLTAGE DIPS AND INTERRUPTIONS (DIPS)	23
13.1 Test Specification.....	23
13.2 Block Diagram of EUT Test Setup.....	23
13.3 Test Procedure.....	23
13.4 Test Result.....	23
14. EUT PHOTOGRAPHS	24
15. TEST SETUP PHOTOGRAPHS	28

1. VERSION

Report No.	Issue Date	Description	Approved
E ZKT-2104191296	Apr. 22, 2021	Original	Valid

2. GENERAL INFORMATION

2.1 Description of Device (EUT)

EUT : Electronic Refrigerant Scale

Trademark : N/A

Model Number : LMC-100F
LMC-100A, LMC-200, LMC-200A, LMC-210, LMC-210A, LMC-300, LMC-300A,
LMC-310, LMC-310A, LMC-210L, LMC-300L

Model Difference : Model name

Power Supply : DC 9V by the battery

2.2 Tested System Details

None.

2.3 Test Facility

Shenzhen ZKT Technology Co., Ltd.
Add. : 1/F, No. 101, Building B, No. 6, Tangwei Community Industrial Avenue, Fuhai Street, Bao'an District, Shenzhen, China

FCC Test Firm Registration Number: 692225
Designation Number: CN1299
IC Registered No.: 27033

2.4 MEASUREMENT UNCERTAINTY

Where relevant, the following measurement uncertainty levels have been estimated for tests performed on the Product as specified in CISPR 16-4-2. This uncertainty represents an expanded uncertainty expressed at approximately the 95% confidence level using a coverage factor of k=2.

Test item	Value (dB)
Conducted Emission (150K-30MHZ)	3.20
Radiated disturbance30MHz-1000MHz	4.80
Radiated disturbance1000MHz-6000MHz	5.10

2.5 Test Instrument Used
Conducted emissions Test

Item	Kind of Equipment	Manufacturer	Type No.	Serial No.	Last calibration	Calibrated until
1	LISN	R&S	ENV216	101471	Sep. 22, 2020	Sep. 21, 2021
2	LISN	CYBERTEK	EM5040A	E18504001 49	Sep. 22, 2020	Sep. 21, 2021
3	Test Cable	N/A	C01	N/A	Sep. 22, 2020	Sep. 21, 2021
4	Test Cable	N/A	C02	N/A	Sep. 22, 2020	Sep. 21, 2021
5	EMI Test Receiver	R&S	ESRP3	101946	Sep. 22, 2020	Sep. 21, 2021
6	Absorbing Clamp	DZ	ZN23201	N/A	Sep. 22, 2020	Sep. 21, 2021

Radiated emissions Test (966 chamber)

Item	Kind of Equipment	Manufacturer	Type No.	Serial No.	Last calibration	Calibrated until
1	Bilog Antenna	Schwarzbeck	VULB9168	00877	Sep. 22, 2020	Sep. 21, 2021
2	Loop Antenna	SCHWARZBECK	FMZB1519B	014	Sep. 22, 2020	Sep. 21, 2021
3	Test Cable	N/A	R-01	N/A	Sep. 22, 2020	Sep. 21, 2021
4	Test Cable	N/A	R-02	N/A	Sep. 22, 2020	Sep. 21, 2021
5	EMI Test Receiver	R&S	ESCI7	101169	Sep. 22, 2020	Sep. 21, 2021
6	Antenna Mast	EM	SC100_1	N/A	N/A	N/A
7	Turn Table	EM	SC100	N/A	N/A	N/A
8	Spectrum Analyzer	KEYSIGHT	9020A	MY5537083 5	Sep. 22, 2020	Sep. 21, 2021
9	Horn Antenna (1GHz-18GHz)	Schwarzbeck	BBHA9120D	1541	Sep. 22, 2020	Sep. 21, 2021
10	Horn Antenna (18GHz-40GHz)	A.H. System	SAS-574	588	Sep. 22, 2020	Sep. 21, 2021
11	Amplifier (30-1000MHz)	EM Electronics	EM330 Amplifier	N/A	Sep. 22, 2020	Sep. 21, 2021
12	Amplifier (1GHz-40GHz)	Quanjuda	DLE-161	097	Sep. 22, 2020	Sep. 21, 2021

Harmonic / Flicker Test

Item	Kind of Equipment	Manufacturer	Type No.	Serial No.	Last calibration	Calibrated until
1	Harmonic & Flicker	LAPLACE INSTRUMENTS	C2000A	311370	Sep. 22, 2020	Sep. 21, 2021
2	AC Power Source	LAPLACE INSTRUMENTS	C2000A	311370	Sep. 22, 2020	Sep. 21, 2021

Electrostatic discharge Test

Item	Kind of Equipment	Manufacturer	Type No.	Serial No.	Last calibration	Calibrated until
1	ESD TEST GENERATOR	HTEC	HESD16	N/A	Sep. 22, 2020	Sep. 21, 2021

Continuous RF electromagnetic field disturbances Test (SMQ --- site)

Item	Kind of Equipment	Manufacturer	Type No.	Serial No.	Last calibration	Calibrated until
1	Signal Generator	R&S	SMT 06	832080/007	Sep. 22, 2020	Sep. 21, 2021
2	Log-Bicon Antenna	Schwarzbeck	VULB9161	4022	Sep. 22, 2020	Sep. 21, 2021
3	Power Amplifier	AR	150W1000M 1	320946	Sep. 22, 2020	Sep. 21, 2021
4	Microwave Horn Antenna	AR	AT4002A	321467	Sep. 22, 2020	Sep. 21, 2021
5	Power Amplifier	AR	25S1G4A	308598	Sep. 22, 2020	Sep. 21, 2021

EFT and Surge and Voltage dips and interruptions Test

Item	Kind of Equipment	Manufacturer	Type No.	Serial No.	Last calibration	Calibrated until
1	Surge Generator	HTEC	HCOMPACT 5	202501	Sep. 22, 2020	Sep. 21, 2021
2	DIPS Generator	HTEC	HV1P16T	202101	Sep. 22, 2020	Sep. 21, 2021
3	EFT/B Generator	HTEC	HCOMPACT 5	202501	Sep. 22, 2020	Sep. 21, 2021
4	EFT/B Clamp	HTEC	H3C	N/A	Sep. 22, 2020	Sep. 21, 2021

3. CONDUCTED EMISSIONS

3.1 Block Diagram Of Test Setup

For mains ports:

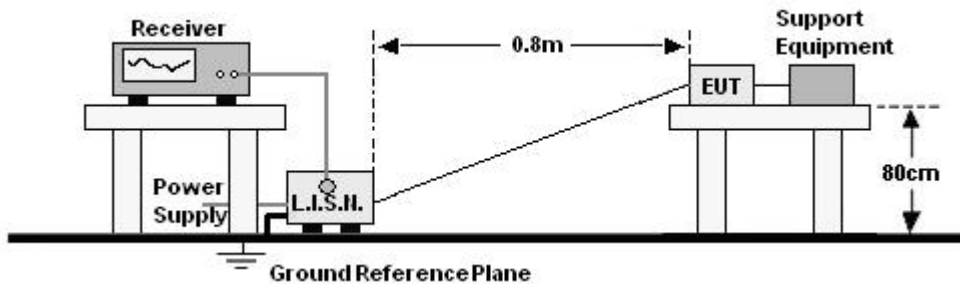

3.2 Limit

Limits for Conducted emissions at the mains ports of Class B MME

Frequency range (MHz)	Limits dB(μ V)	
	Quasi-peak	Average
0,15 to 0,50	66 to 56*	56 to 46*
0,50 to 5	56	46
5 to 30	60	50

Notes: 1. *Decreasing linearly with logarithm of frequency.
2. The lower limit shall apply at the transition frequencies.

3.3 Test procedure

For mains ports:

- The Product was placed on a nonconductive table 0.8 m above the horizontal ground reference plane, and 0.4 m from the vertical ground reference plane, and connected to the main through Line Impedance Stability Network (L.I.S.N).
- The RBW of the receiver was set at 9 kHz in 150 kHz ~ 30MHz with Peak and AVG detector in Max Hold mode. Run the receiver's pre-scan to record the maximum disturbance generated from Product in all power lines in the full band.
- For each frequency whose maximum record was higher or close to limit, measure its QP and AVG values and record.

3.4 Test Result

The EUT is powered by the DC only, the test item is not applicable.

4. RADIATED DISTURBANCE TEST

4.1 Block Diagram Of Test Setup

30MHz ~ 1GHz:

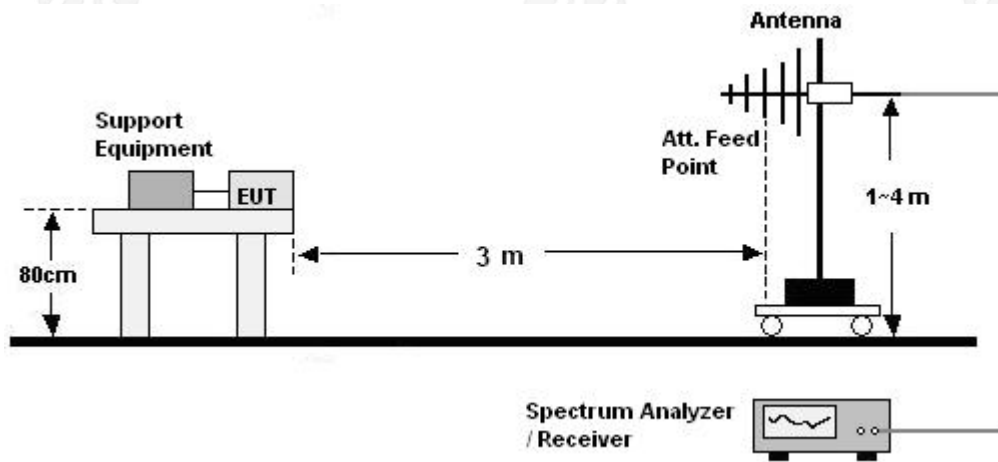

4.2 Limits

Frequency (MHz)	Quasi-peak limits at 3m dB(μ V/m)
30-230	40
230-1000	47

Note: The lower limit shall apply at the transition frequencies.

4.3 Test Procedure

30MHz ~ 1GHz:

- The Product was placed on the nonconductive turntable 0.8 m above the ground in a semi anechoic chamber.
- Set the spectrum analyzer/receiver in Peak detector, Max Hold mode, and 120 kHz RBW. Record the maximum field strength of all the pre-scan process in the full band when the antenna is varied between 1~4 m in both horizontal and vertical, and the turntable is rotated from 0 to 360 degrees.
- For each frequency whose maximum record was higher or close to limit, measure its QP value: vary the antenna's height and rotate the turntable from 0 to 360 degrees to find the height and degree where Product radiated the maximum emission, then set the test frequency analyzer/receiver to QP Detector and specified bandwidth with Maximum Hold Mode, and record the maximum value.

4.4 Test Results

Radiated disturbances Test Data			
Temperature:	25.3°C	Relative Humidity:	55%
Pressure:	1011hPa	Phase :	Horizontal
Test Voltage :	DC 9V	Test Mode:	Normal mode

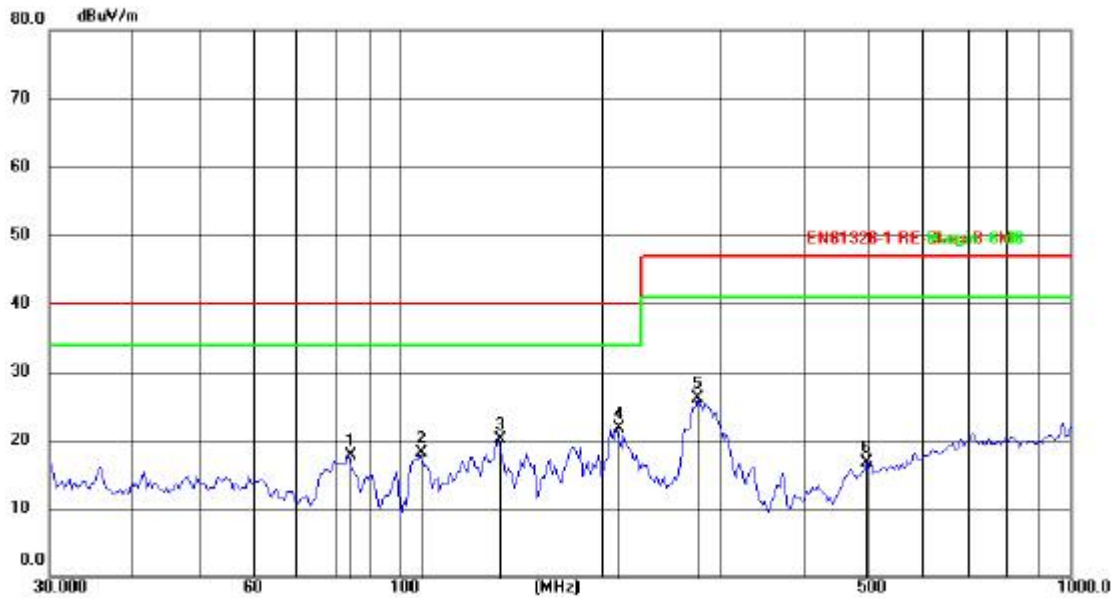

No.	Frequency (MHz)	Reading (dBuV)	Factor (dB/m)	Level (dBuV/m)	Limit (dBuV/m)	Margin (dB)	Detector
1	83.6688	37.45	-19.73	17.72	40.00	-22.28	QP
2	106.9461	37.59	-19.46	18.13	40.00	-21.87	QP
3	140.3421	37.52	-17.32	20.20	40.00	-19.80	QP
4	210.0482	41.15	-19.39	21.76	40.00	-18.24	QP
5	278.0668	42.39	-16.24	26.15	47.00	-20.85	QP
6	495.9344	30.58	-13.83	16.75	47.00	-30.25	QP

Radiated disturbances Test Data			
Temperature:	25.3℃	Relative Humidity:	55%
Pressure:	1011hPa	Phase :	Vertical
Test Voltage :	DC 9V	Test Mode:	Normal mode

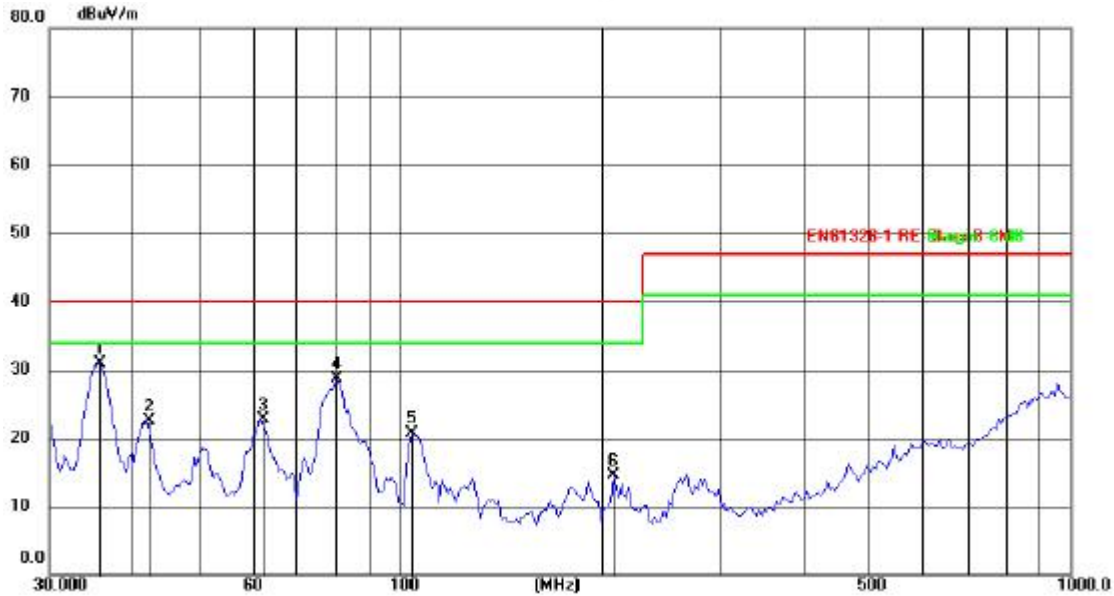

No.	Frequency (MHz)	Reading (dBuV)	Factor (dB/m)	Level (dBuV/m)	Limit (dBuV/m)	Margin (dB)	Detector
1	35.4371	48.42	-17.54	30.88	40.00	-9.12	QP
2	41.8596	39.42	-16.94	22.48	40.00	-17.52	QP
3	62.1039	41.33	-18.53	22.80	40.00	-17.20	QP
4	80.7857	50.46	-21.84	28.62	40.00	-11.38	QP
5	104.1701	42.03	-21.28	20.75	40.00	-19.25	QP
6	208.2148	36.17	-21.65	14.52	40.00	-25.48	QP

Remark:
Factor = Antenna Factor + Cable Loss – Pre-amplifier.

5. HARMONIC CURRENT EMISSION TEST

5.1 Block Diagram of Test Setup

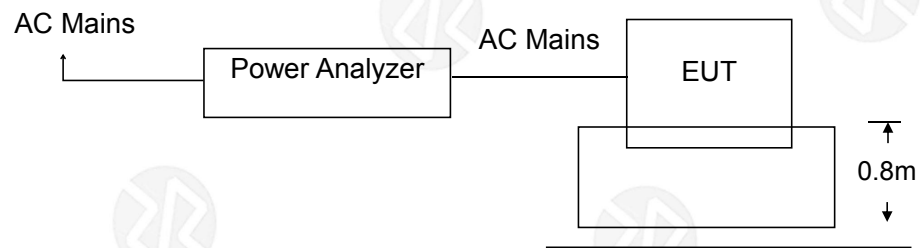

5.2 Test Standard

EN 61000-3-2:2014

5.3 Operating Condition of EUT

- 5.3.1 Setup the EUT as shown in Section 6.1.
- 5.3.2 Turn on the power of all equipment.
- 5.3.3 Let the EUT work in test mode and test it.

5.4 Test Procedure

The power cord of the EUT is connected to the output of the test system. Turn on the power of the EUT and use the test system to test the harmonic current level.

5.5 Test Results

The EUT is powered by the DC only, the test item is not applicable.

6. VOLTAGE FLUCTUATIONS & FLICKER TEST

6.1 Block Diagram of Test Setup

Same as Section 6.1.

6.2 Test Standard

EN 61000-3-3:2013+A1:2019

6.3 Operating Condition of EUT

Same as Section 5.3.. The power cord of the EUT is connected to the output of the test system. Turn on the power of the EUT and use the test system to test the harmonic current level.

Flicker Test Limit

Test items	Limits
Pst	1.0
dc	3.3%
dmax	4.0%
dt	Not exceed 3.3% for 500ms

6.4 Test Procedure

The power cord of the EUT is connected to the output of the test system. Turn on the power of the EUT and use the test system to test the harmonic current level.

6.5 Test Results

The EUT is powered by the DC only, the test item is not applicable.

7. IMMUNITY TEST OF GENERAL THE PERFORMANCE CRITERIA

Product Standard	EN 61326-1:2013
CRITERION A	During testing, normal performance within the specification limits.
CRITERION B	During testing, temporary degradation, or loss of function or performance which is self-recovering.
CRITERION C	During testing, temporary degradation, or loss of function or performance which requires operator intervention or system reset occurs.

8. ELECTROSTATIC DISCHARGE (ESD)

8.1 Test Specification

Test Port	: Enclosure port
Discharge Impedance	: 330 ohm / 150 pF
Discharge Mode	: Single Discharge
Discharge Period	: one second between each discharge

8.2 Block Diagram of Test Setup

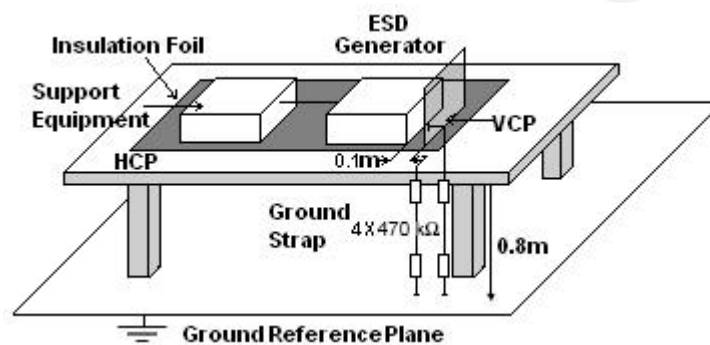

8.3 Test Procedure

- Electrostatic discharges were applied only to those points and surfaces of the Product that are accessible to users during normal operation.
- The test was performed with at least ten single discharges on the pre-selected points in the most sensitive polarity.
- The time interval between two successive single discharges was at least 1 second.
- The ESD generator was held perpendicularly to the surface to which the discharge was applied and the return cable was at least 0.2 meters from the Product.
- Contact discharges were applied to the non-insulating coating, with the pointed tip of the generator penetrating the coating and contacting the conducting substrate.
- Air discharges were applied with the round discharge tip of the discharge electrode approaching the Product as fast as possible (without causing mechanical damage) to touch the Product. After each discharge, the ESD generator was removed from the Product and re-triggered for a new single discharge. The test was repeated until all discharges were complete.

g. At least ten single discharges (in the most sensitive polarity) were applied to the Horizontal Coupling Plane at points on each side of the Product. The ESD generator was positioned vertically at a distance of 0.1 meters from the Product with the discharge electrode touching the HCP.

h. At least ten single discharges (in the most sensitive polarity) were applied to the center of one vertical edge of the Vertical Coupling Plane in sufficiently different positions that the four faces of the Product were completely illuminated. The VCP (dimensions 0.5m x 0.5m) was placed vertically to and 0.1 meters from the Product.

8.4 Test Results

Discharge Method	Discharge Position	Voltage (±kV)	Min. No. of Discharge per polarity (Each Point)	Required Level	Performance Criterion
Contact Discharge	Conductive Surfaces	4	10	B	A
	Indirect Discharge HCP	4	10	B	A
	Indirect Discharge VCP	4	10	B	A
Air Discharge	Slots, Apertures, and Insulating Surfaces	8	10	B	A
Note: N/A					

9. ELECTROMAGNETIC FIELD (RS)

9.1 Test Specification

Test Port	:	Enclosure port
Step Size	:	1%
Modulation	:	1kHz, 80% AM
Dwell Time	:	1 second
Polarization	:	Horizontal & Vertical

9.2 Block Diagram of Test Setup

Below 1GHz:

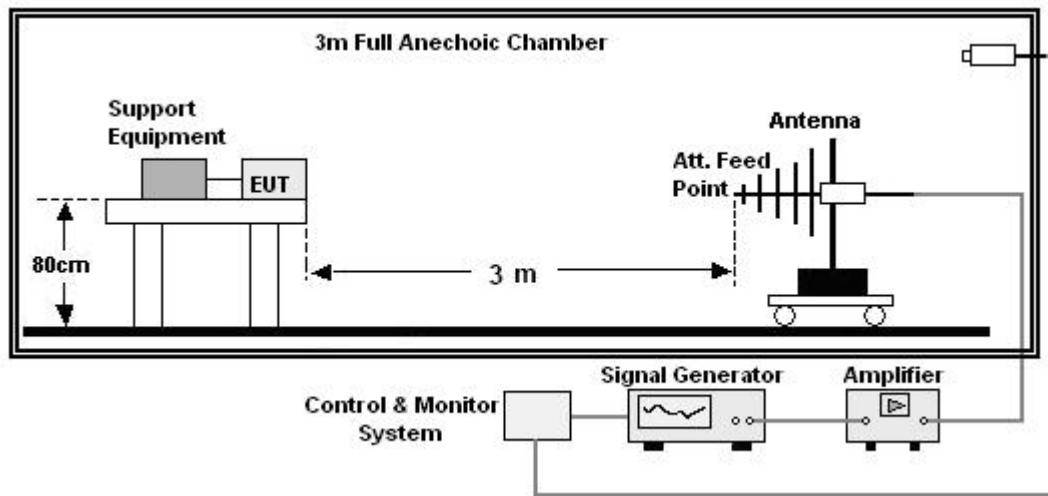

Above 1GHz:

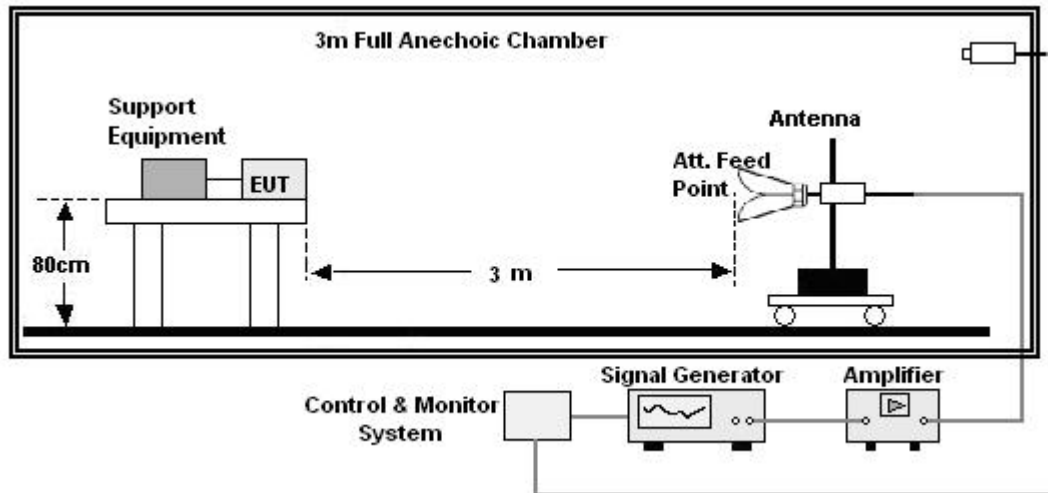

9.3 Test Procedure

- a. The testing was performed in a fully-anechoic chamber. The transmit antenna was located at a distance of 3m or 1m from the Product.
- b. The frequency range is swept from 80MHz to 1000MHz and 1400MHz to 2700MHz, with the signal 80% amplitude modulated with a 1 kHz sine wave. The rate of sweep did not exceed 1.5×10^{-3} decade/s. Where the frequency range is swept incrementally, the step size was 1%.
- c. The test was performed with the Product exposed to both vertically and horizontally polarized fields on each of the four sides.

9.4 Test Results

Frequency	Position	Field Strength (V/m)	Required Level	Performance Criterion
80 - 1000	Front, Right, Back, Left	10	A	A
1400 - 2000	Front, Right, Back, Left	3	A	A
2000 - 2700	Front, Right, Back, Left	1	A	A
Note: N/A				

10. ELECTRICAL FAST TRANSIENTS/BURST (EFT)

10.1 Test Specification

Test Port	:	input a.c. power port
Impulse Frequency	:	5 kHz
Impulse Wave-shape	:	5/50 ns
Burst Duration	:	15 ms
Burst Period	:	300 ms
Test Duration	:	2 minutes per polarity

10.2 Block Diagram of EUT Test Setup

For input a.c. power port:

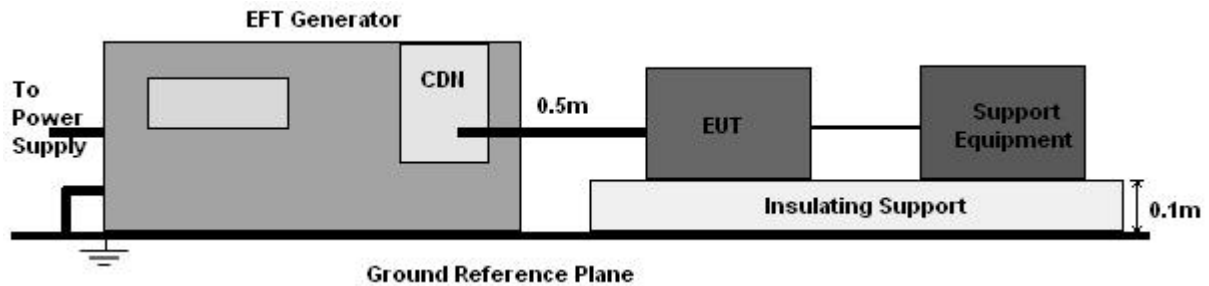

10.3 Test Procedure

- The Product and support units were located on a non-conductive table above ground reference plane.
- A 0.5m-long power cord was attached to Product during the test.

10.4 Test Results

Coupling	Voltage (kV)	Polarity	Required Level	Performance Criterion
AC Mains L-N	1.0	±	B	N/A

Note: The EUT is powered by the DC only, the test item is not applicable.

11. SURGES IMMUNITY TEST

11.1 Test Specification

Test Port	: input a.c. power port
Wave-Shape	: Open Circuit Voltage - 1.2 / 50 us Short Circuit Current - 8 / 20 us
Pulse Repetition Rate	: 1 pulse / min.
Phase Angle	: 0° / 90° / 180° / 270°
Test Events	: 5 pulses (positive & negative) for each polarity

11.2 Block Diagram of EUT Test Setup

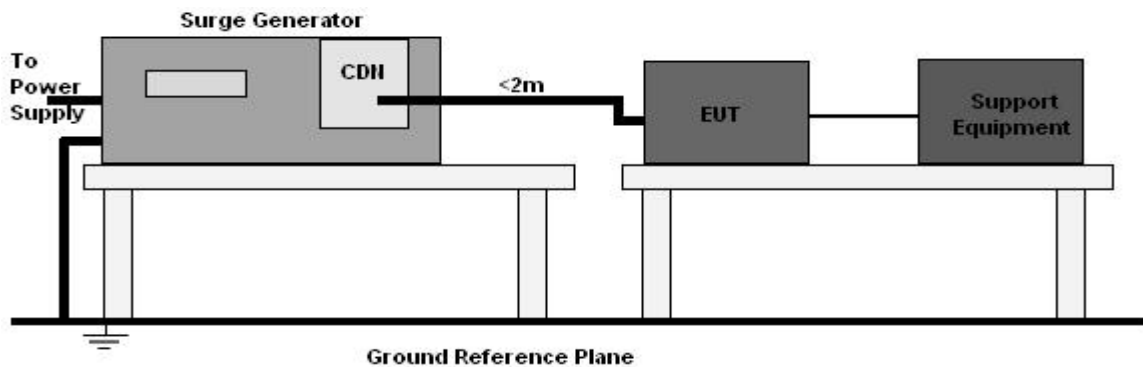

11.3 Test Procedure

- The surge is to be applied to the Product power supply terminals via the capacitive coupling network. Decoupling networks are required in order to avoid possible adverse effects on equipment not under test that may be powered by the same lines, and to provide sufficient decoupling impedance to the surge wave.
- The power cord between the Product and the coupling/decoupling networks shall be 2 meters in length (or shorter). Interconnection line between the Product and the coupling/decoupling networks shall be 2 meters in length (or shorter).

11.4 Test Result

Coupling Line	Voltage (kV)	Phase Angle	Required Level	Performance Criterion
L - N	+1	90°	B	N/A
	-1	270°	B	N/A

Note: The EUT is powered by the DC only, the test item is not applicable.

12. CONTINUOUS INDUCED RF DISTURBANCES (CS)

12.1 Test Specification

Test Port	:	input a.c. power port
Step Size	:	1%
Modulation	:	1kHz, 80% AM
Dwell Time	:	1 second

12.2 Block Diagram of EUT Test Setup

For input a.c. power port:

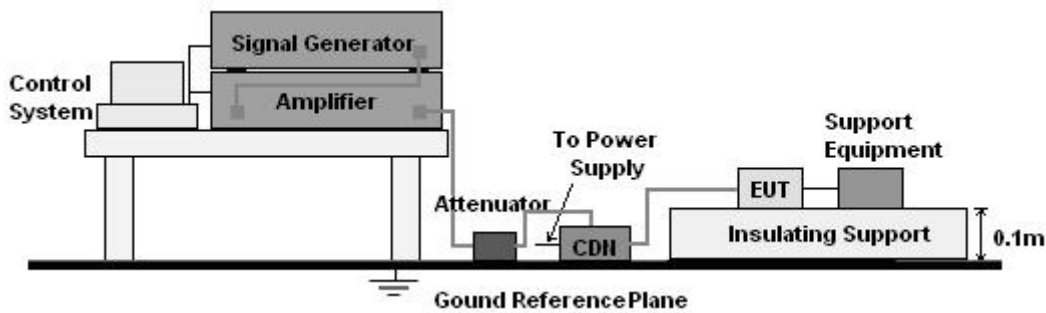

12.3 Test Procedure

For input a.c. power port:

- a. The Product and support units were located at a ground reference plane with the interposition of a 0.1 m thickness insulating support and the CDN was located on GRP directly.
- b. The frequency range is swept from 150 kHz to 10MHz, 10MHz to 30MHz, 30MHz to 80MHz with the signal 80% amplitude modulated with a 1 kHz sine wave, and the step size was 1% of fundamental.
- c. The dwell time at each frequency shall be not less than the time necessary for the Product to be able to respond.

12.4 Test Result

Inject Line	Frequency (MHz)	Voltage Level (V r.m.s.)	Required Level	Performance Criterion
a.c. port	0.15 - 10	3	A	N/A
	10 to 30	3 to 1	A	N/A
	30 to 80	1	A	N/A

Note: The EUT is powered by the DC only, the test item is not applicable.

13. VOLTAGE DIPS AND INTERRUPTIONS (DIPS)

13.1 Test Specification

Test Port : input a.c. power port
Phase Angle : 0°, 180°
Test cycle : 3 times

13.2 Block Diagram of EUT Test Setup

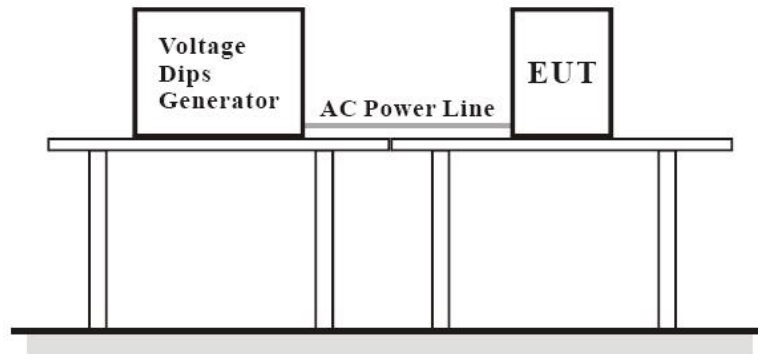

13.3 Test Procedure

- The Product and support units were located on a non-conductive table above ground floor.
- Set the parameter of tests and then perform the test software of test simulator.
- Conditions changes to occur at 0 degree crossover point of the voltage waveform.

13.4 Test Result

Test Level % U_T	Voltage dips in % U_T	Duration (ms)	Required Level	Performance Criterion
< 5	≥95	10	B	N/A
70	30	500	C	N/A
Voltage Interruptions:				
< 5	≥95	5000	C	N/A
Note: The EUT is powered by the DC only, the test item is not applicable.				

14. EUT PHOTOGRAPHS

EUT Photo 1

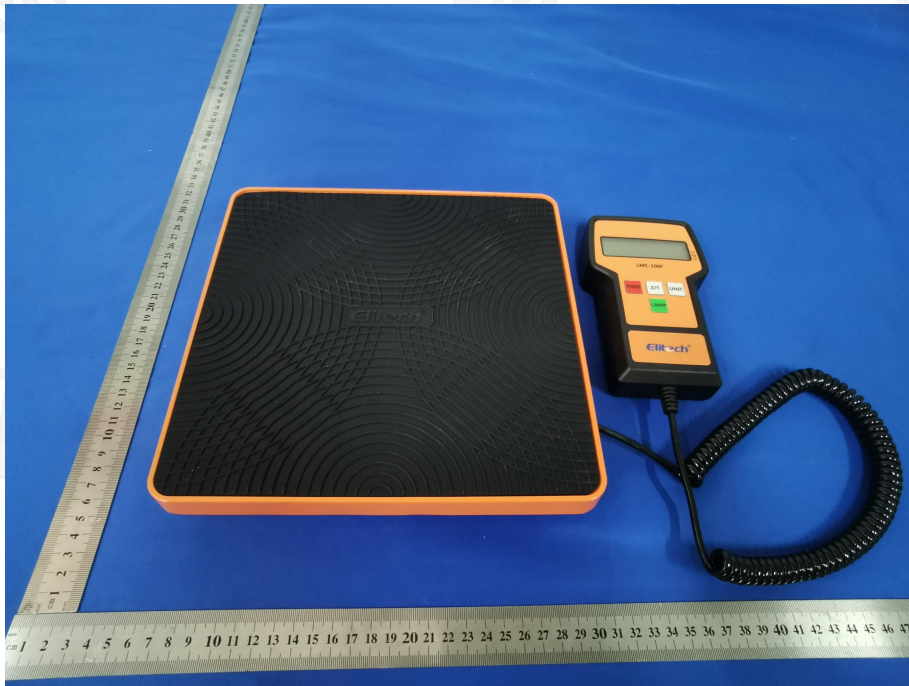

EUT Photo 2



EUT Photo 3

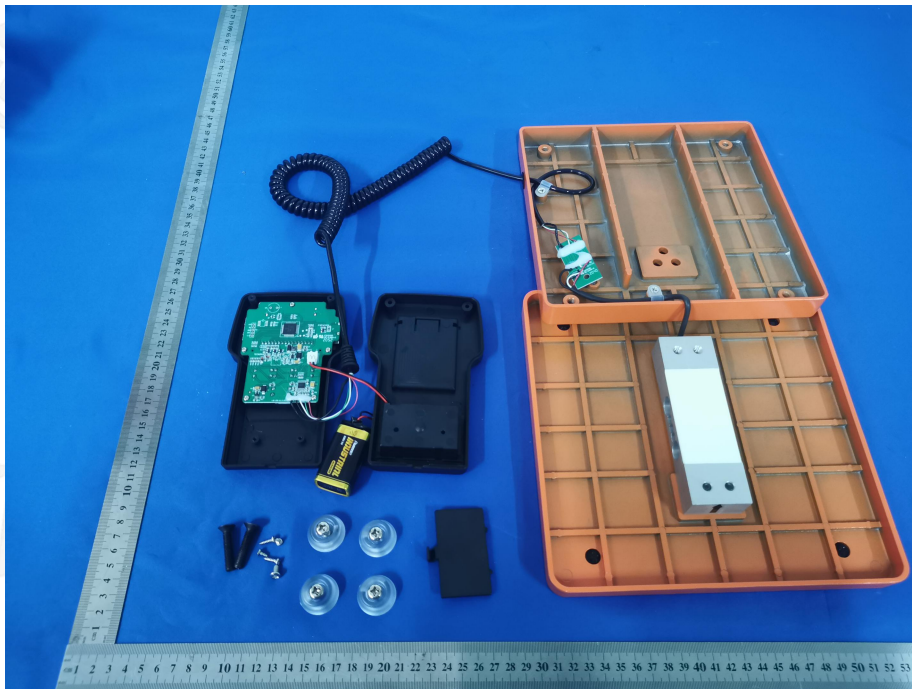

EUT Photo 4

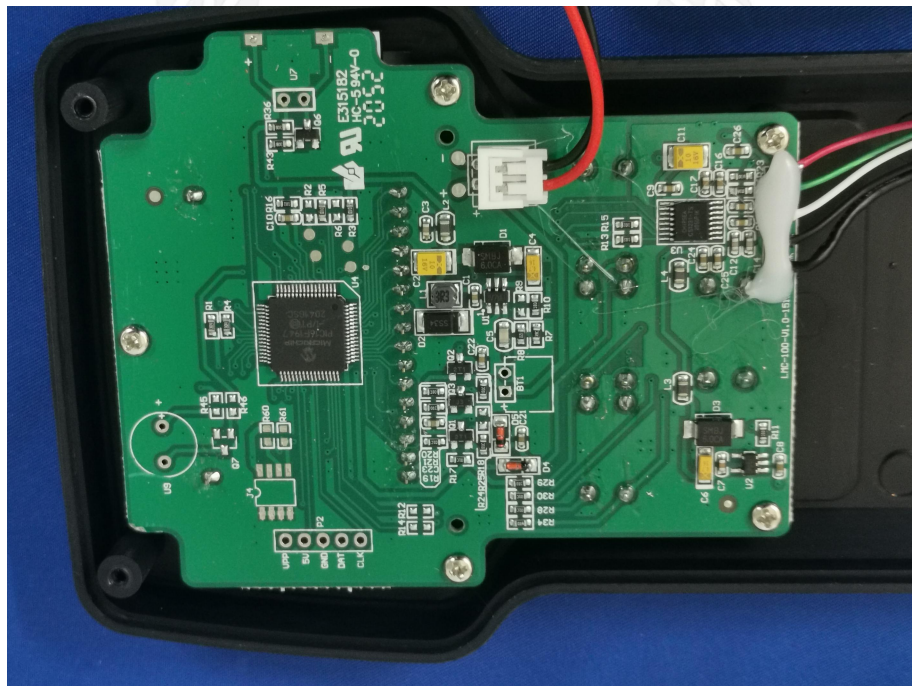

EUT Photo 5

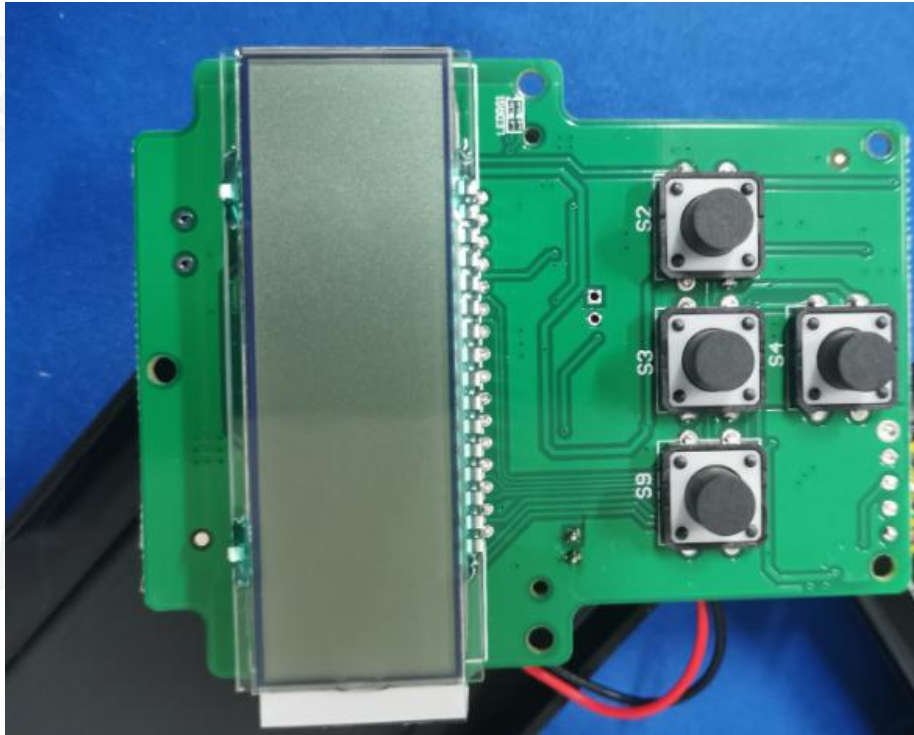

EUT Photo 6

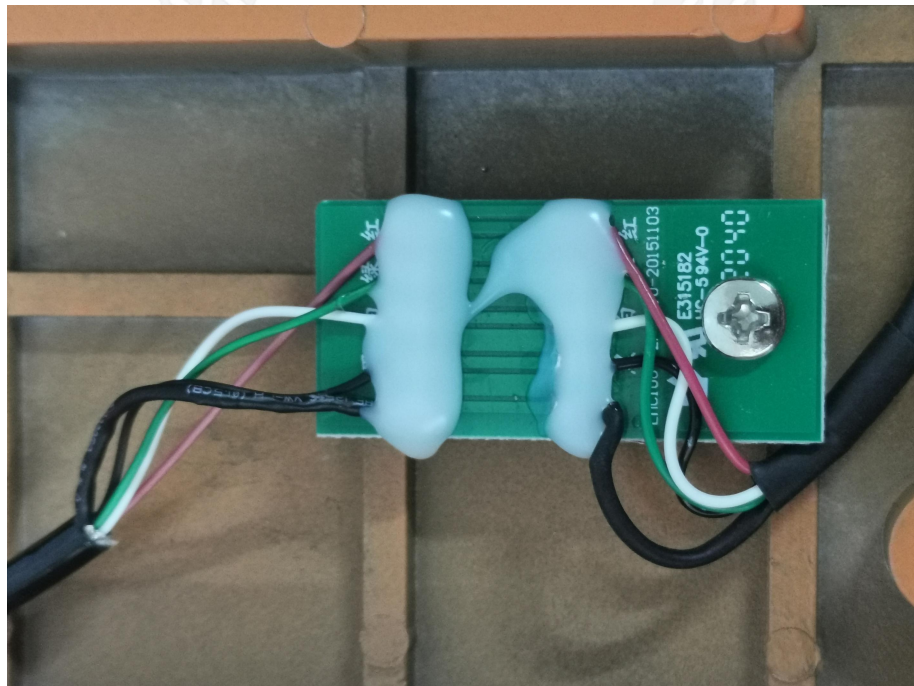

EUT Photo 7



EUT Photo 8



15. TEST SETUP PHOTOGRAPHS

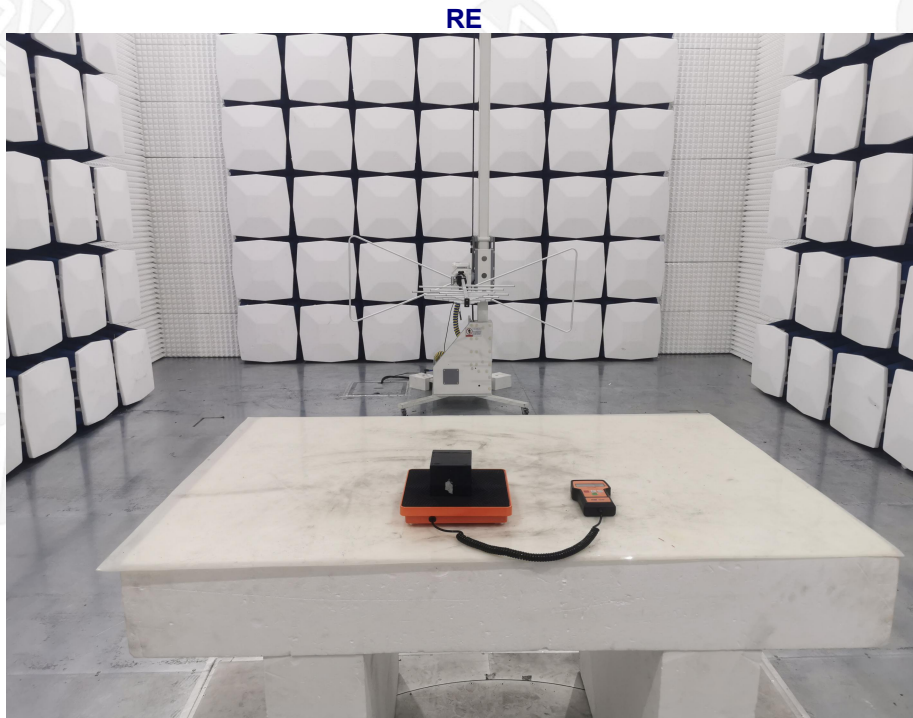

***** END OF REPORT *****